

Tiny-Tach™ for DIESEL

- Solid State, Quartz Crystal control
- Vibration and water resistant
- Engine RPM to 10,000. Correct reading regardless of the number of cylinders
- All units are backlit for night viewing.
- Microprocessor with Flash memory so internal battery power is not needed.
- Connects to 12 VDC vehicle power.

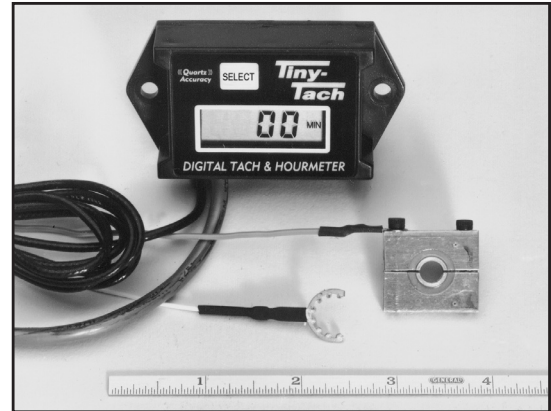

Made in USA

Operating Instructions:

1. ATTACH TINY-TACH unit to desired location. Insure that signal cable will reach area where the transducer is to be mounted on the fuel injection line.
2. INSTALL TRANSDUCER: If there is paint on the injection line, remove by scraping or sand-papering a narrow section of line so that the inside diameter of the transducer will make direct metal contact with the fuel line.

Connect RED lead of signal cable to transducer housing (ring terminal under mounting screw).

Mount transducer on fuel line as shown in Fig. 1. Be sure to use correct transducer size corresponding to injection line size, or damage to the transducer may result when tightened.

Tighten socket head cap screws very firmly using 3/32 inch (2.38mm) hex key.

Ground WHITE lead (with grounding lug) to a good engine ground. NOTE: Do not attach transducer to a section of fuel line that is bent, curved or flattened. **KEEP CABLE AWAY FROM HOT ENGINE PARTS.**

3. EXTERNAL POWER: External power is required to operate the unit. Vehicle power is most convenient, but any DC 12 VOLTS source may be used. From the grey two wire power cable, connect the RED wire to the POSITIVE of the source and the BLACK wire to the NEGATIVE terminal of the source. **Note: to avoid possible starter surge damage to unit please connect to radio circuit (or a circuit that is off during starting)**
4. After the transducer pick-up has been installed on the fuel injection line, check to be sure it is not touching any part of the engine except the injection line to which it is attached. After operation is checked out and unit is to be permanently left on engine, it is recommended that the transducer be completely sprayed with paint to insure protection from weather or other contamination.
5. OPERATION: When engine is started, the unit will automatically switch to the TACH MODE. When the engine is shut off and no transducer signal is present, the unit will switch to indicate Total Run Time (TOT), beginning in minutes and switching to hours after 60 minutes is reached only when the 12 volt DC power is on.

Operating instructions

Tach and Total

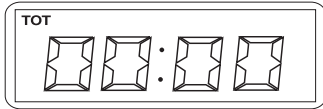

FUNCTION- Displays engine RPM when engine is running. Displays Total Hours when engine is off

Job

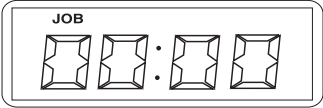

FUNCTION- count up timer

VIEW- Press select 1 time

RESET- Press select 1 time and hold until "RESET" appears in window release to reset.

SVC - Service

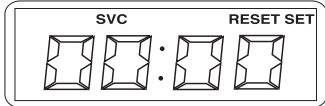

FUNCTION- count down timer 0-250hrs

VIEW- Press select 2 times

RESET Service alarm- Press select 2 times and hold until "RESET" appears and release. Window now displays service interval time.

SET - Press select 2 times and hold until "RESET" appears in window and continue to hold until "SET" appears, then let go. Now press select again to adjust the service hours. Each press will change hours in 10 hr increments.

SVC2 - Service 2

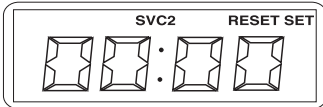

FUNCTION- count down timer 0-50 hours

VIEW- Press select 3 times

RESET Service alarm- Press select 3 times and hold until "RESET" appears and release. Window now displays service interval time.

RESET - Press select 3 times and hold until "RESET" appears in window and continue to hold until "SET" appears, then let go. Now press select again to adjust the service hours. Each press will change hours in 5 hr increments.

MAX - Max rpm

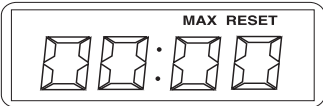

FUNCTION- Maximum RPM

VIEW- Press select 4 times

RESET - Press select 4 times and hold until "RESET" appears in window and release.

Panel mounted

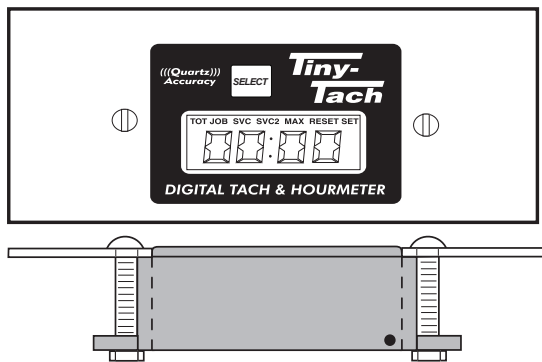

Surface mounted

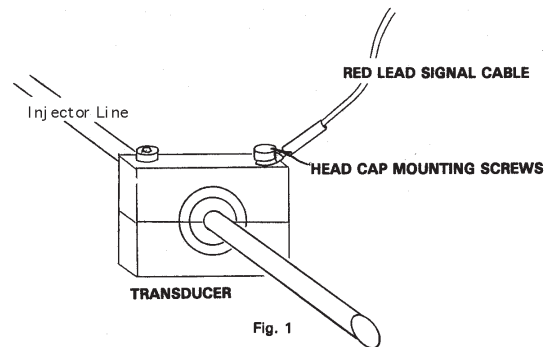
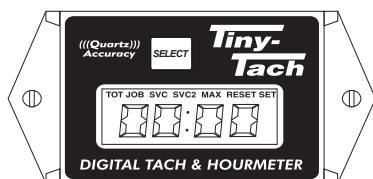

Fig. 1

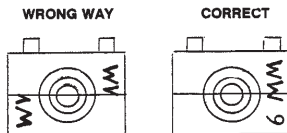

Fig. 2



Design Technology, Inc.
768 Burr Oak Drive
Westmont, IL 60559
630.920.1300
Fax: 630.920.0011

www.tinytach.com